

VERY



Carat Felt L lamp

It requires art, skill and science to transform a rough stone into a faceted gem. This intricate modular lampshade design was conceived with the same ingredients, and consists of 9 identical segments and an astounding 36 facets. The tactile recycled PET felt used for the shade makes this lamp also an excellent acoustic dampener.

Material

Recycled PET felt segments, steel frame.

Packaging quantity

Sold individually.

Designer

Sander Mulder



Felt colors

23 colors available, see next page.

Ceiling cover-, Cable-, Fitting-, Frame color

black

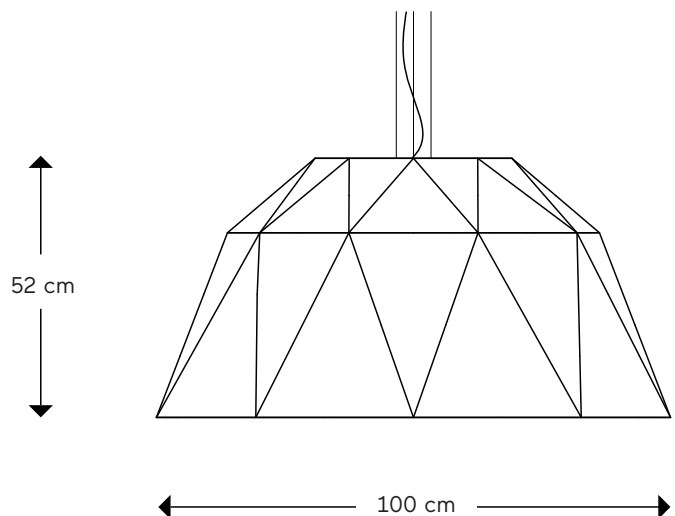

VERY



PET felt

Characteristics

A minimum of 50% of our felt is composed of recycled PET beverage bottles.

Thickness: 9 mm

Density: 1.9 kg/m²

Application

Thanks to the large variety of colors we can offer, the felt panels can be used in any environment from office spaces and hotels to public buildings and classrooms.



Colors

Slight color deviations may occur since PET Felt panels are made from recycled fibers.



Recycled & recyclable



Sound absorption



Fire retardant
Bs1- 0d0



Made from
PET bottles



BZ-07



BZ-05



BZ-43

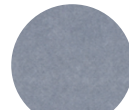

BZ-47

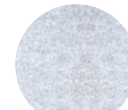

BZ-11



BZ-12



BZ-04



BZ-46

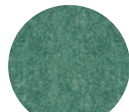

BZ-10

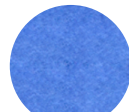

BZ-25

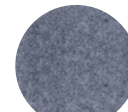

BZ-36

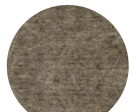

BZ-31



BZ-33



BZ-08



BZ-17

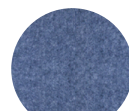

BZ-09

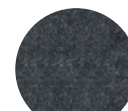

BZ-03



BZ-39



BZ-35

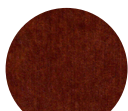

BZ-48

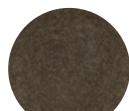

BZ-34

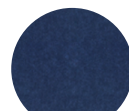

BZ-19



BZ-13